

EM25MA-BK

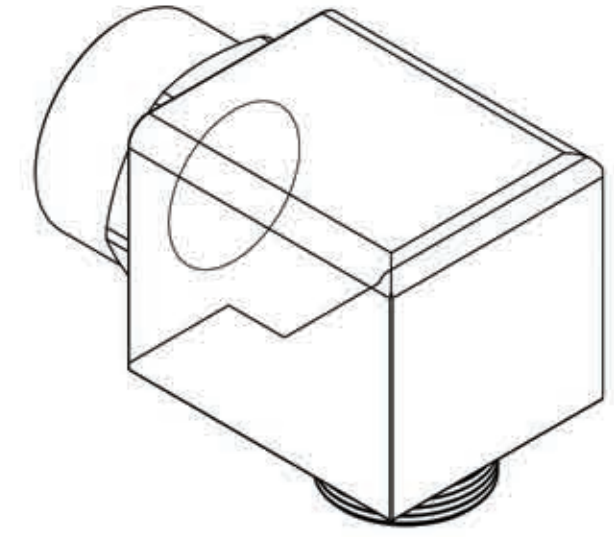
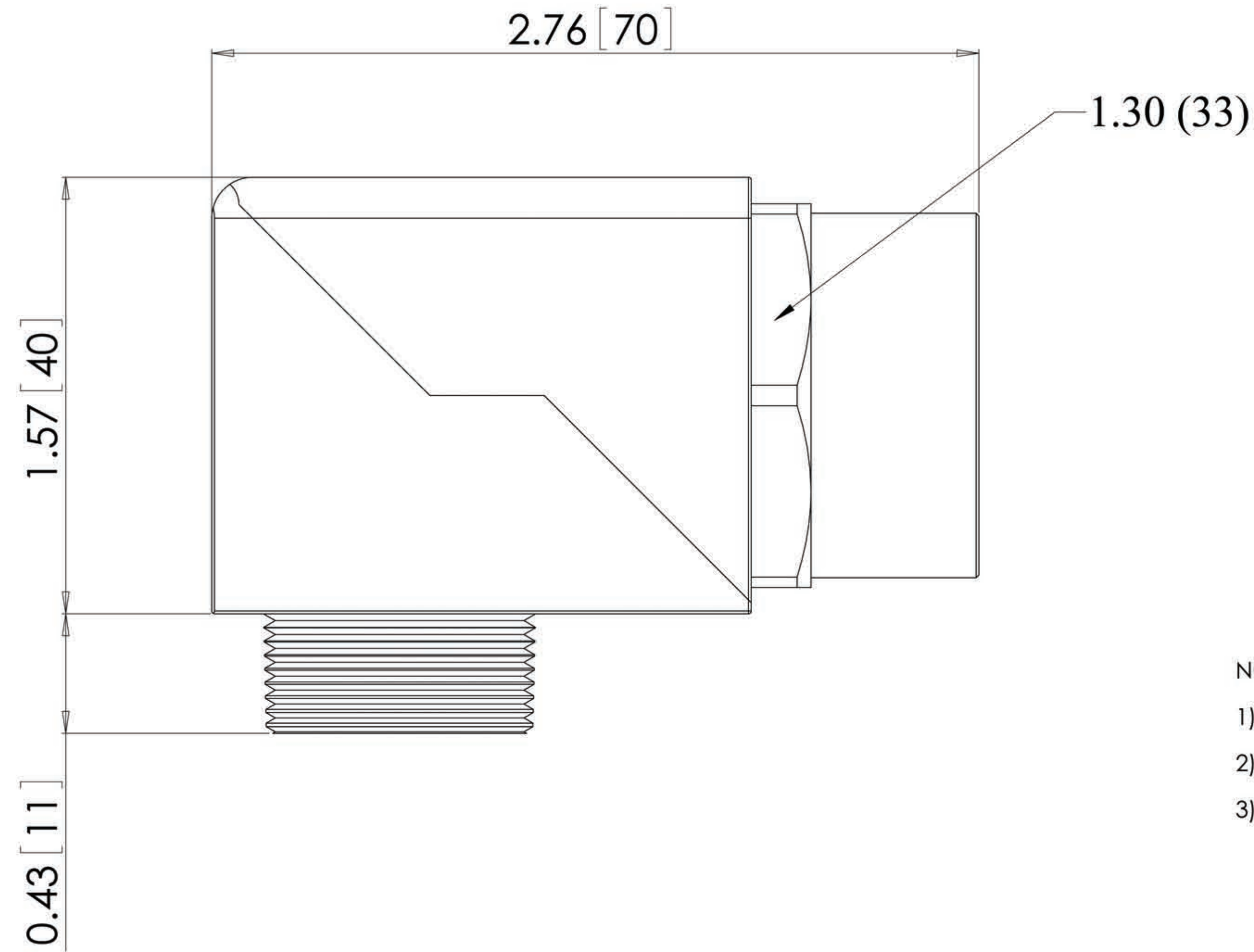

NOTES:

- 1) GENERAL DIMENSIONS DRAWINGS.
- 2) DIMENSIONS [] ARE IN MILLIMETER.
- 3) DIMENSIONS NOTED ARE FOR REFERENCE ONLY.

Third angle projection

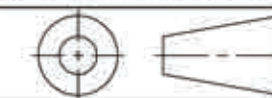

SEALCON

7374 S. EAGLE STREET
CENTENNIAL, CO 80112-4221 USA
TOLL FREE: 1-800-456-9012
PHONE: 303-699-1135
EMAIL: info@SealconUSA.com
WEBSITE: www.SealconUSA.com

