

EMI-RFI Elongated Dome and Flex Fittings
PG-NPT-Nickel Plated Brass

CF11CA-BE

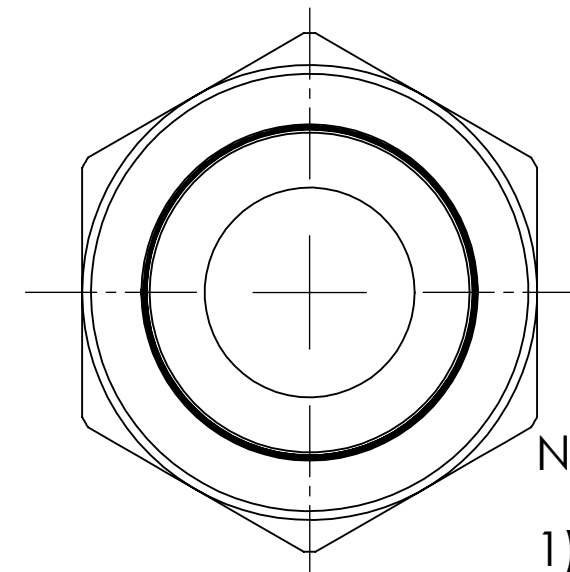
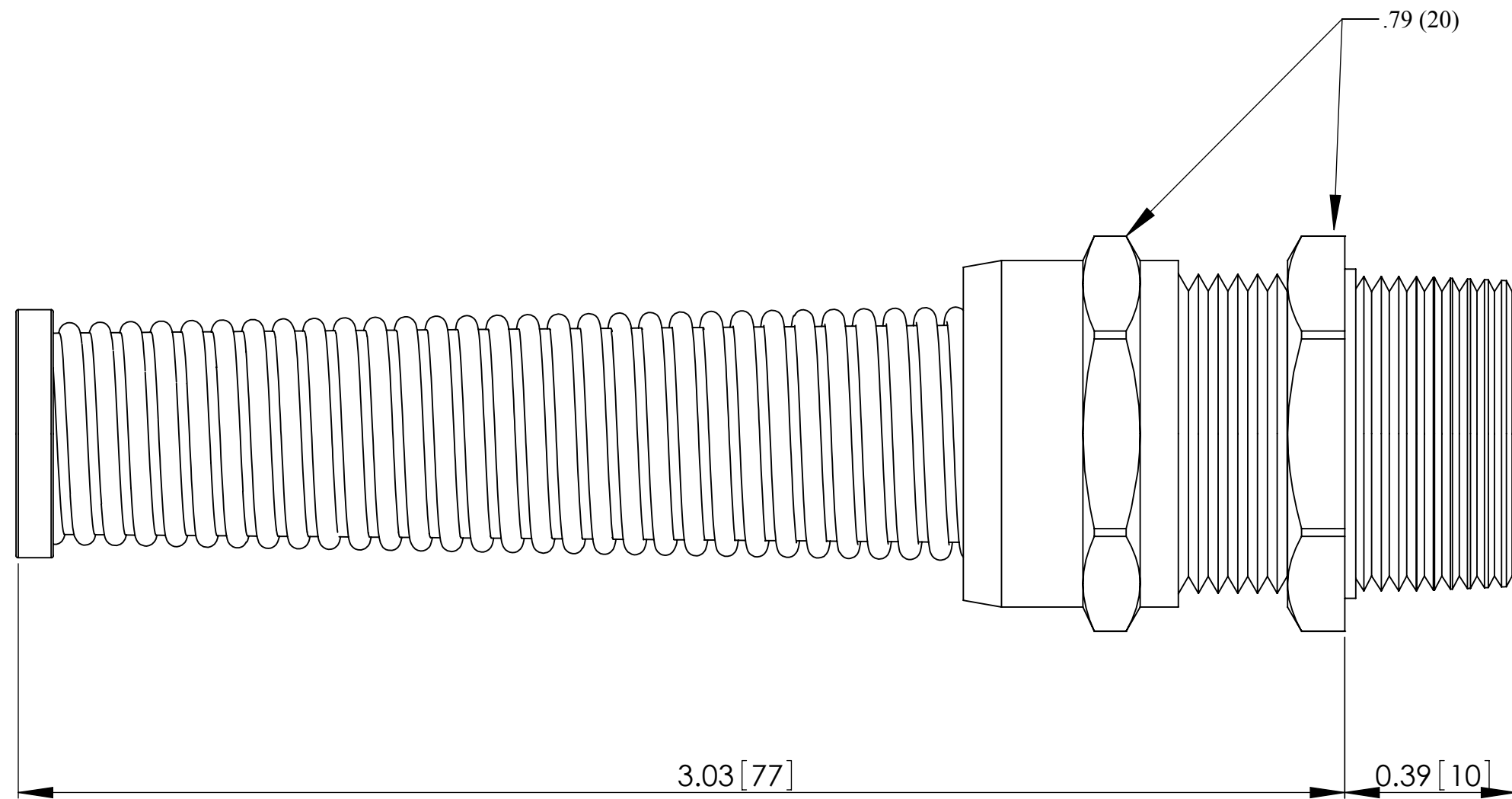
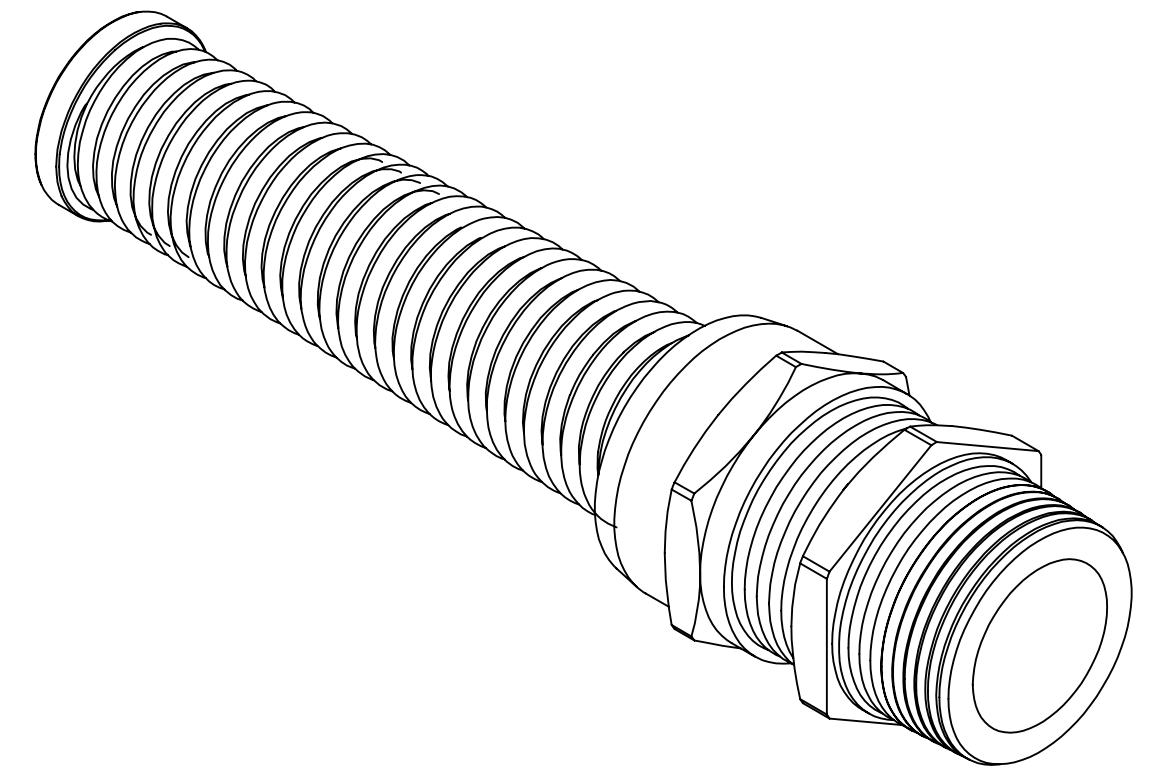

NOTES:

- 1) GENERAL DIMENSIONS DRAWINGS.
- 2) DIMENSIONS [] ARE IN MILLIMETER.
- 3) DIMENSIONS NOTED ARE FOR REFERENCE ONLY.

Third angle projection

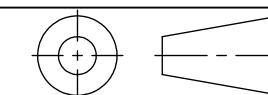

14853 E HINDSDALE AVE, SUITE D
CENTENNIAL, CO 80112-4240, USA
TEL: +1-303-699-1135
TOLL FREE: +1-800-456-9012
E MAIL: info@sealconusa.com,
WEBSITE: www.sealconusa.com

