

ID	Description	Date	By	Appr.
A				

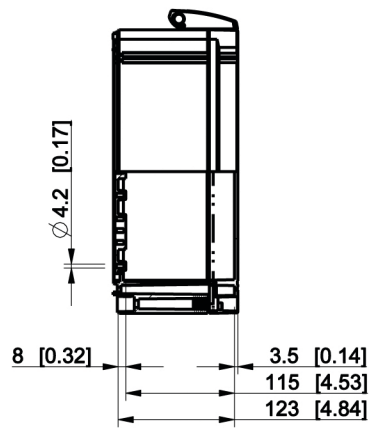
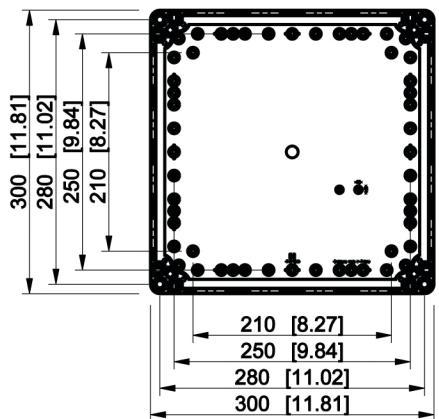
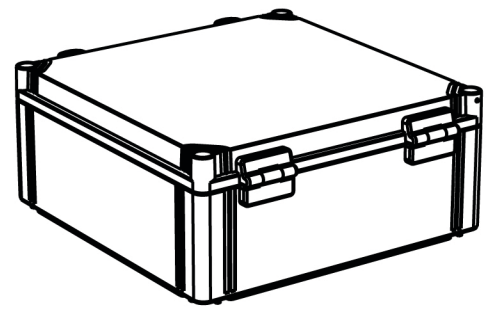
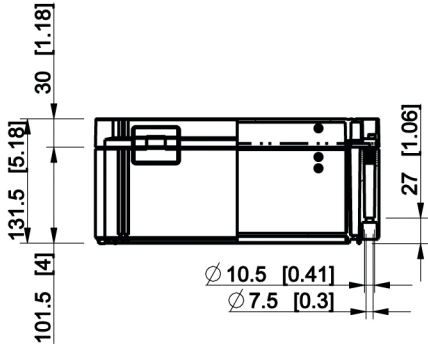

Dimensions in mm [inches]

Material: Polycarbonate, fiberglass-reinforced		Color: RAL 7035	
Supplier:		Tool No:	
Scale	Date	Volume:	
1:8	02.01.09	Replaces:	
-	By	Replaced:	
-	PKos	Drw No: A	
-	Checked	Ref: Series W	
-	Ctrl	Code: S3140074339GU	
		Sheet No:	

model drawing