





## Empty enclosures in accordance with IEC 62208



**EB 25 G**

- Built-in dimensions W 170 x H 220 x D 96 mm





- for installation equipment on DIN rails or mounting plates (order separately)
- with opaque lid
- fastener for tool operation
- sealable
- box walls without knockouts
- external brackets for wall fixing included
- colour: grey, RAL 7035
- material: PC (polycarbonate)

rated insulation voltage	$U_i = 1000 \text{ V a.c./d.c.}$
impact strength	IK 09 (10 Joule)
static load	mounting plate or DIN rail = 4.4 kg lid = 1.2 kg
power dissipation capability at $\Delta\theta = 40 \text{ K}$	$P_{de} = 20 \text{ watts}$
wall thickness	ümbriß = 2.5 mm lid = 2 mm
material	PC-GFS (polycarbonate)
degree of protection	IP 66
mounting width	220 mm
mounting height	170 mm
max. installation depth	96 mm
width	255 mm
height	205 mm
depth	112 mm
weight	0,645 kg
in accordance with	IEC 62208:2011

### Drawings

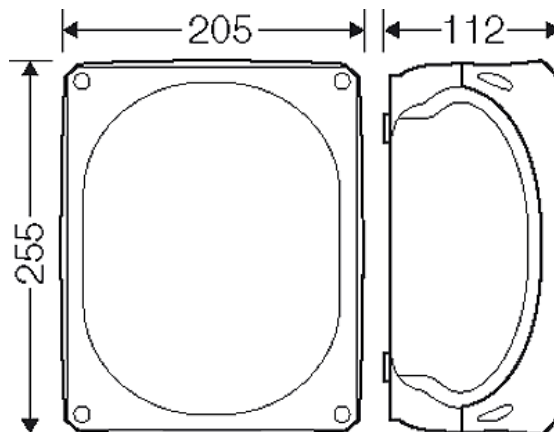
Dimension drawing





## Empty enclosures in accordance with IEC 62208



**EB 25 G**

- Built-in dimensions W 170 x H 220 x D 96 mm

Detail mass

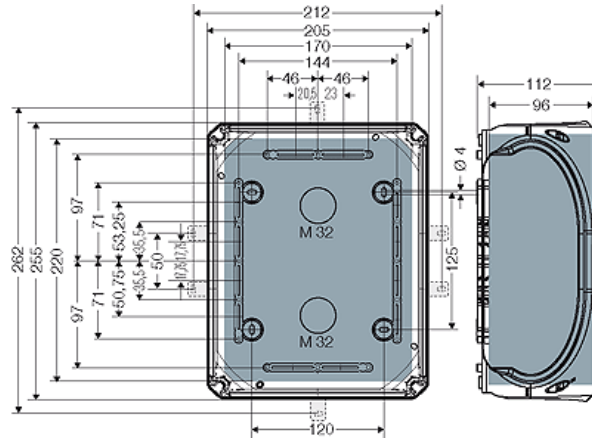

### Operating and ambient conditions

Application area	"weatherproof" resistant to weather influences (UV due to solar radiation, protected against rainwater, temperature resistant, impact resistant, etc.) To reduce the formation and accumulation of condensed water see technical information.
Ambient temperature	Average value over 24 hours + 55 °C Maximum value + 70 °C Minimum value - 25 °C
Fire protection in the event of internal faults	Demands placed on electrical devices from standards and laws Minimum requirements - Glow wire test in accordance with IEC 60695-2-11: - 650° C for boxes and cable glands
Burning behaviour	960 °C V-0
Degree of protection against mechanical load	IK09 (10 Joule)
Toxic behaviour	halogen-free silicone-free "halogen-free" in accordance with the examination of the cables and insulated wires - corrosiveness of fumes - as per IEC 60754-2
Note:	For material properties see technical data.