

Approved for intrinsic fire resistance, material: Thermoplastic



FK 0402

- Cable junction box 1.5 mm², Cu
- Connection box 1.5-2.5 mm², Cu

IP
65/66

E30
E60
E90

PH120

- 5-pole per pole 4 x 1.5 mm² r and 2 x 2.5 mm² r
- connecting terminal made from ceramic with resistance to high temperatures
- included cable entry: 3 EDKF 25, sealing range: Ø 9-17 mm, IP 65
- IP 66 using AKMF cable glands, please order separately
- intrinsic fire resistance in accordance with DIN 4102-12 (German standard) in combination with function-retaining cables
- tested with the cable manufacturers Dätwyler and Eupen for the intrinsic fire resistance E30 up to E90, see test certificate no.: P-MPA-E-15-018 valid till 9 May 2026, download available from www.hensel-electric.de > type - documents
- tested for insulation integrity PH120 in accordance with BS EN 50200 in connection with insulation retaining cables, see test certificate, download available from www.hensel-electric.de > type - documents
- screw anchors enclosed can be used for concrete C20/25, limestone blocks KSV 12, building bricks MZ 12 and clinker bricks KS 12
- for normal environment and protected outdoor
- colour: orange, RAL 2003

rated insulation voltage	U _i = 400 V a.c./d.c.
rated current:	24 A
material	PC-GFS (polycarbonate)
tightening torque for terminal	0.5 Nm
degree of protection	IP 65
degree of protection	IP 66 (AKMF)
height	104 mm
width	104 mm
depth	70 mm
weight	0,371 kg
in accordance with	DIN 4102 part 12 IEC 60670-22 BS EN 50200

Drawings

Dimension drawing

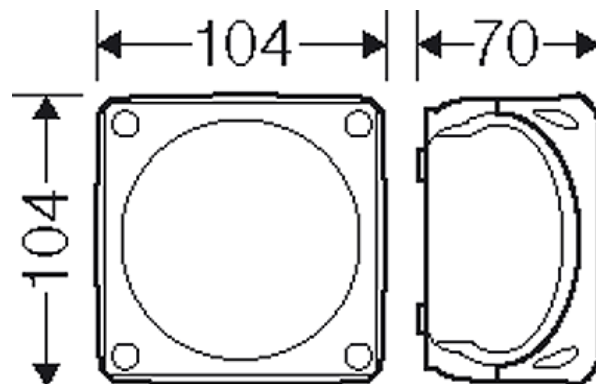

Approved for intrinsic fire resistance, material: Thermoplastic



FK 0402

- Cable junction box 1.5 mm², Cu
- Connection box 1.5-2.5 mm², Cu

IP
65/66

E30
E60
E90

PH120

Detail mass

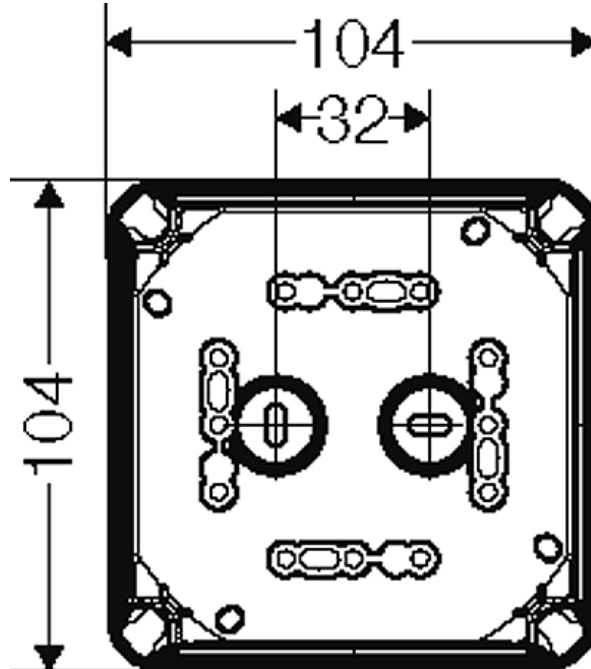

Box walls

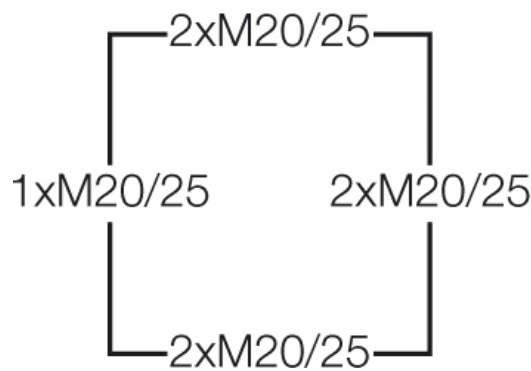

Operating and ambient conditions

Application area	Suitable for indoor installation and outdoor installation, protected against weather influences
Ambient temperature	Average value over 24 hours + 35 °C Maximum value + 40 °C Minimum value - 25 °C
Relative humidity	50% at 40° C short-time 100% at 25° C

Degree of protection against mechanical load

IK09 (10 Joule)

Toxic behaviour

silicone-free
halogen-free
"halogen-free" in accordance with the examination of the cables
and insulated wires - corrosiveness of fumes - as per IEC 60754-2