

"Waterproof", for encapsulating



WP 1006 G

- 1.5-6 mm², Cu 3~







- with terminals
- 5-pole per pole 6 x 1,5 mm² r / f, 4 x 2,5 mm² r / f, 4 x 4 mm² r / f, 4 x 6 mm² r / f, 2 x 10 mm² r / f
- cable entries via knockouts, order AKM separately (see cable entry systems LES)
- cable junction box for encapsulating
- for ground installation without live loads or in risk of condensation formation and ingress of liquids
- usable for heating cable / heating tape up to max. 70 °C surface temperature
- with sealing compound and sealing plug
- In case of re-installation or testing the sealing compound can be removed easily
- durability of sealing compound to processing ≥ 12 months at a storage temperature of 5 - 50 °C
- external brackets for wall fixing included
- colour: grey, RAL 7035

degree of protection	IP 68 submersion up to 20 meter, 168 hours
rated insulation voltage	U _i = 690 V a.c./d.c.
rated current:	40 A
material	PC-GFS (polycarbonate)
width	180 mm
height	130 mm
depth	77 mm
weight	1,687 kg
tightening torque for terminal	1.5 Nm
in accordance with	EN 60670-1 DIN VDE V 0606-22-100

Drawings

Dimension drawing

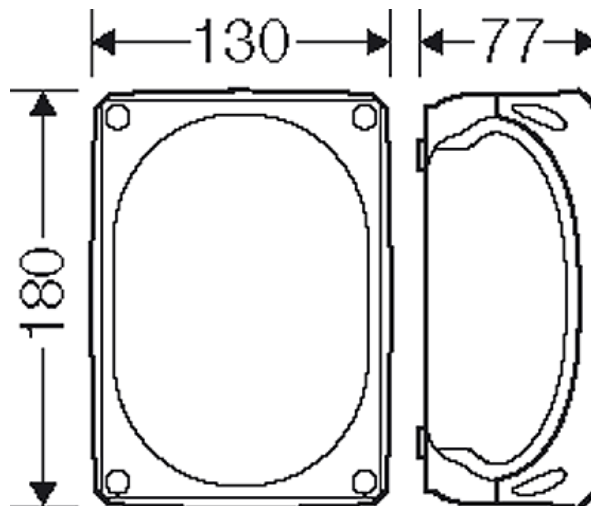

"Waterproof", for encapsulating



WP 1006 G

- 1.5-6 mm², Cu 3~



Detail mass

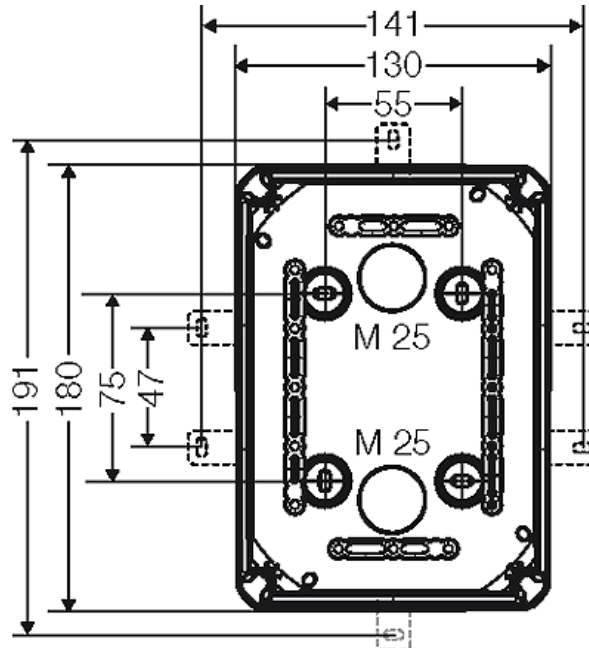

Box walls

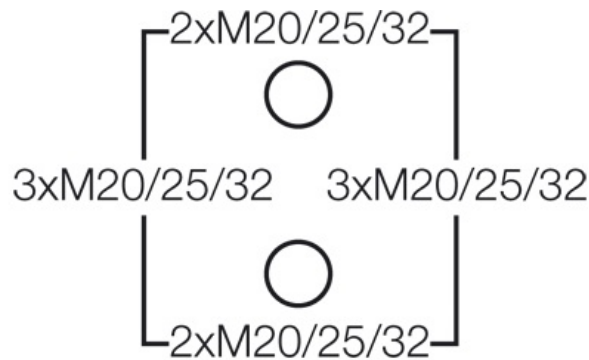





Operating and ambient conditions

Application area	Suitable for outdoor installation (harsh environment and/or outdoor). For application in ambient conditions with formation of condensation and ingress of water as well as for installation in the ground without traffic loads in accordance with DIN VDE V 0606-22-100. Submersion up to 20 meter, 168 hours, IP 68.
Resistant to occasional cleaning procedures (direct jet)	Resistant to occasional cleaning procedures (direct jet) with high-pressure cleaner without additives, water temperature: max. 80° C
Ambient temperature	Average value over 24 hours + 55 °C Maximum value + 70 °C Minimum value - 25 °C

Relative humidity	100 %
Burning behaviour	Glow wire test IEC 60695-2-11: 960 °C UL Subject 94: V-0 flame-retardant self-extinguishing

"Waterproof", for encapsulating

	WP 1006 G <ul style="list-style-type: none">• 1.5-6 mm², Cu 3~ 	  
---	--	---

Degree of protection against mechanical load	IK09 (10 Joule)
Toxic behaviour	halogen-free silicone-free isocyanate-free