

# M23 RJ45 CONNECTORS

## SAFE DATA TRANSFERS

The M23 RJ45 connector is built for industrial environments and meets CAT 5, 5e or CAT 6a requirements. With the proper patch cable, they can be directly integrated into the body of the connector. With a screw lock system, these connectors are also suitable as a maintenance interface and include a built-in cable gland. This system achieves an IP 67 / IP 69K protection class. EMI ready options!

### Ideal in Low Voltage Applications!

- SCADA & RTU's
- Data Collection



Integrated Female coupler accommodates off-the-shelf RJ45 patch cables

Mechanical Data	Materials and Technical Data
Housing	Brass Alloy Die Cast
Housing surface	Nickel plated
Inserts (for contacts)	PBT UL-94 V0, PA 6
Contacts	Brass Alloy
Contact surface at point of contact	Depends On RJ45 Type Used
Seals / O-Rings	Buna-N (Black) / FKM (Green)
Temperature range	Depends On RJ45 Type Used
Degree of Protection	IP 67 per EN 60 529 (mated)
Cable diameter range	3 - 7 / 7 - 12 / 11 - 17 mm
Number of Positions	4 / 6 / 8 poles, Optional 4 + 2 / 6 + 2 / 8 + 2
Nominal Current [A]	Depends On RJ45 Type Used
Nominal Voltage [V~]	Depends On RJ45 Type Used
Test Voltage [V~]	Depends On RJ45 Type Used
Insulation Resistance [MΩ]	Depends On RJ45 Type Used
Max. Crossover Resistance [mΩ]	Depends On RJ45 Type Used
Max. Data Rate	Depends On RJ45 Type Used, IAW CAT5/5e/6a

#### Components Needed For A Complete M23 RJ45 Connector:

- HOUSING (pages 33 - 35)
- INSERT Included



Ex-i RJ45 Approved  
Connectors: See Page 76



SEE TECHNICAL INFORMATION PAGE 80

\*ASSEMBLY INSTRUCTIONS CAN BE FOUND AT [WWW.SEALCONUSA.COM](http://WWW.SEALCONUSA.COM) OR BY CALLING US AT 1-800-456-9012

# M23 RJ45 CONNECTORS

## HOUSINGS

### M23 RJ45 Straight Connector, EMI, Female Thread

MUST USE YAMAICHI Y-CON SQUARE PLUG - SEE PAGE 35

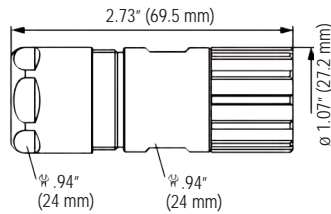

Cable-Ø

Part Number

3 – 7 mm (.12 - .28").....S7.R10.400.000  
Connector with Insert for Patch Cable

Suitable Patch Cable and Plugs can be Recommended.

### M23 RJ45 Straight Connector, EMI, Male Thread

FEMALE / FEMALE COUPLER

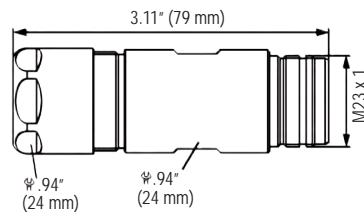

Cable-Ø

Part Number

3 – 7 mm (.12 - .28").....S7.R20.408.000  
Includes 8 poles Coupler, Fully Occupied

### M23 RJ45 Panel Connector, Male Thread, Dip Solder Insert, Flange

DIP SOLDER INSERT

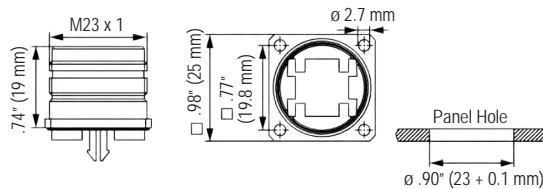

Type

Part Number

Front Mounting, Flange 25 x 25 mm  
4 x Holes Ø 2.7 mm.....S7.R40.008.000  
Includes 8 poles dip solder insert

4 x Holes Ø 2.7 mm.....S7.R40.082.000  
Includes 8 + 2 poles Dip Solder Insert

### M23 RJ45 Panel Connector, Male Thread, Flange

FEMALE/FEMALE COUPLER

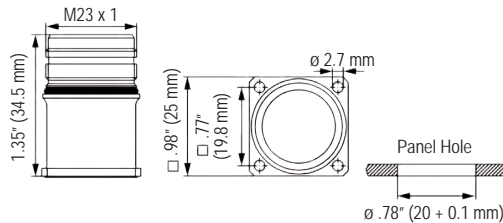

Type

Part Number

Front Mounting, Flange 25 x 25 mm  
4 x Holes Ø 2.7 mm,.....S7.R41.008.000  
Includes 8 poles coupler, Fully Occupied

### M23 RJ45 Panel Connector, Single Hole, Male Thread

FEMALE/FEMALE COUPLER

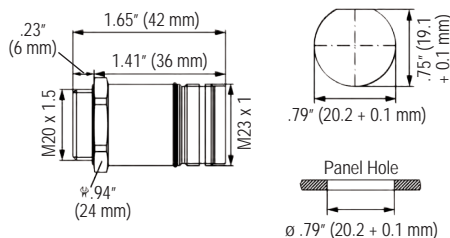

Type

Part Number

Front Mounting, Single Hole  
M20 x 1.5 thread .....S7.R42.008.000  
Includes 8 poles Coupler, Fully Occupied

Optional: Gasket M20 x 1.5, Locking Nut

M23 RJ45 Connectors

# M23 RJ45 CONNECTORS

## HOUSINGS

### M23 RJ45 Panel Connector, Single Hole, Male Thread

FEMALE/FEMALE COUPLER

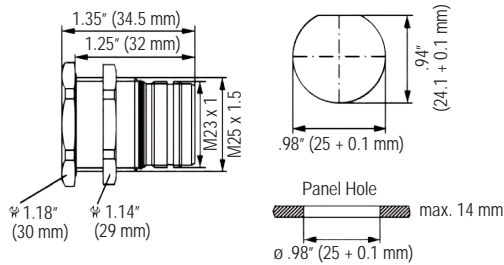

Type	Part Number
Rear Mounting, Single Hole M25 x 1.5 thread .....S7.R50.008.000 Includes 8 poles Coupler, Fully Occupied	
Including Locking Nut M25 x 1.5	

### M23 RJ45 Right Angle Panel Connector, Male Thread, Rotatable 300°

FEMALE/FEMALE COUPLER

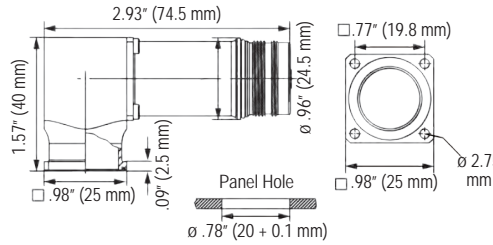
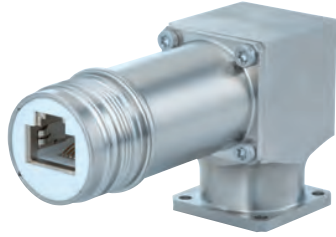

Type	Part Number
300° Rotatable, Flange 25 x 25 mm 4 x Holes Ø 2.7 mm.....S7.R43.108.000 Includes 8 poles Coupler, Fully Occupied	
Optional: Flat Gasket....STAD1-7P2510	
Easy Fastening with: M2.5 x 10 mm Screws	

### M23 RJ45 Panel Connector, Male Thread, Dip Solder Insert, Flange

DIP SOLDER INSERT

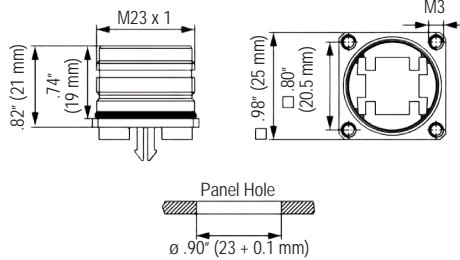

Type	Part Number
Rear Mounting, Flange 25 x 25 mm 4 x Threaded M3.....S7.R45.008.000 Includes 8 poles Dip Solder Insert	
4 x Threaded M3.....S7.R45.082.000 Includes 8 + 2 poles Dip Solder Insert	

### M23 RJ45 Panel Connector w/ Strain Relief, EMI, Single Hole, Male Thread

FEMALE/FEMALE COUPLER

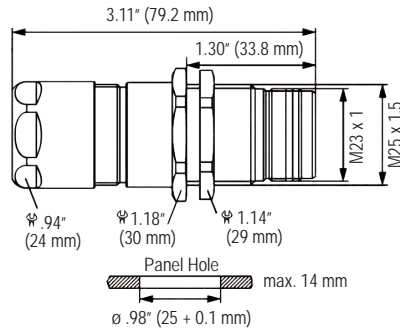

Cable-Ø	Part Number
Rear Mounting, Thread M25 x 1.5, Single Hole 3 - 7 mm (.12 - .28").....S7.R52.408.000	
Includes 8 poles Coupler, Fully Occupied Including Locking Nut M25 x 1.5	

### M23 RJ45 Panel Connector with Strain Relief, EMI, Male Thread

FEMALE/FEMALE COUPLER

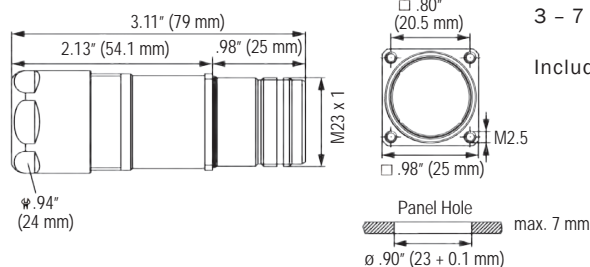











Cable-Ø	Part Number
Rear Mounting, 4 x Threaded M2.5, Flange 25 x 25 mm 3 - 7 mm (.12 - .28").....S7.R47.408.000	
Includes 8 poles Coupler, Fully Occupied	

# M23 RJ45 CONNECTORS

## ACCESSORIES

### M23 RJ45 Accessories

	Plastic Protective Cap for connectors with Male thread..... S7.000.900.101 with Female thread ..... S7.000.900.102		Brass Protective Cap with chain for connectors with female thread Length 70 mm.....S7.010.9S0.783 Length 100 mm.....S7.010.9S1.083
	Brass Protective Cap for connectors with Female thread .....S7.010.900.183		Brass Protective Cap with chain for connectors with Male thread Length 70 mm.....S7.010.9S0.702 Length 100 mm.....S7.010.9S1.002
	Brass Protective Cap for connectors with Male thread ..... S7.010.900.102		Suitable patch cable.....ON REQUEST
	Adapter Flange for Straight Connectors.....S7.010.900.128		Field attachable RJ45 Yamaichi Plug 8-pole.....CAT 5/5e.....SA7RJ-081M41 8-pole.....CAT 6a.....SA7RJ-081M6A 8+2-pole.....CAT 5/5e.....SA7RJ-821M51
	Conduit Adapter Nylon Conduit DN 12.....S7.010.900.205 Nylon Conduit DN 14.....S7.010.900.207 Nylon Conduit DN 17.....S7.010.900.209		Screw Tool, adjustable 0.5 - 1.7 Nm ..... .....S7.010.900.190
	Tool Adapter for tightening or loosening knurled nuts for M23 .....S7.010.900.192		

